

# ROUND MANHOLE COVER SERIES EIXO E DOBRADIÇA C250 and D400

12.100



## Product description

- Round manhole cover series EIXO E DOBRADIÇA
- Water based black painting

## Installation location

- Class C250 - For gully tops, installed in the area of kerbside channels of roads which when measured from the kerb edge, extends a maximum of 0,5 m into the carriageway and a maximum of 0,2 m into the pedestrian area
- Class D400 - Carriageways of roads (including pedestrian streets), hard shoulders and parking areas for all types of road vehicles

## Standards

- Designed according to EN 124-1/2

## Certifications

- Certificate Certif "D400" DDA - 011/2021
- Certificate Certif "Intense Traffic" DDA - 005/2021

## Features

- Ductile cast iron cover and frame (EN-GJS-500-7) with water based black painting
- Cover with non-slip raised pattern according to EN 124-1 designed to allow quick and easy installation
- Hinge system with self-cleaning system, simply opening of the manhole at 120° and safety 90° blocking system. Fit and remove is making through moving the cover to 90° and lift clear.
- Innovative system of conical closing that due to the ramped design, both frame and lock, the cover closes automatically with its own weight or the weight of the first vehicle which passes over. Also allowing the gradual adjustment of the lock with the conical cavity for it in the frame maintaining the absence of glitches. Locking system which allows that the manhole cover can be opened by the inside. If necessary, the lock can be easily replaced, since it's an independent piece
- Elastomer-coated lock to ensure silent operation
- Frame prepared to install the anti-theft system
- The cover have a local to install an additional security lock. This lock may be conventional or inviolable and can be installed at any moment
- Elastic seating which assures the cover perfectly fits the frame and also gives stability and silent operation even in high traffic intensity
- Stability conferred by the 6 guides in the cover for centrally positioned and stability in the frame, while minimizing the movement of the cover relative to the frame, ensures the horizontal and vertical stability of the set
- Personalization of the cover with inscriptions and logo in high relief with minimal quantities.

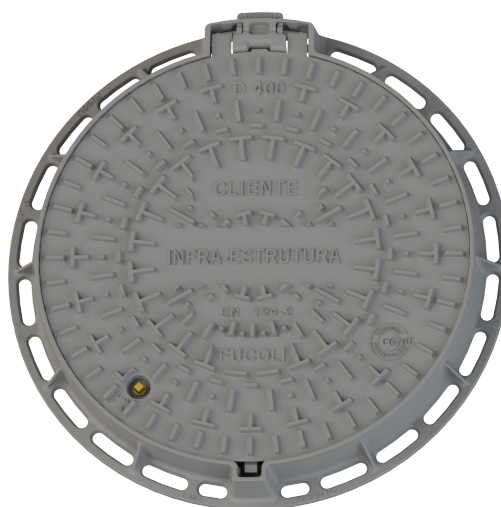

600 - D400



**Fucoli Somepal**  
FUNDAÇÃO DE FERRO, S.A.

Visit our website at [www.fucoli-somepal.pt](http://www.fucoli-somepal.pt)

**Head office:** Estrada de Coselhas, 3000-125 Coimbra – Portugal | Tel.: (+351) 239 490100 | Fax: (+351) 239 490198

**Branch office:** Rua de Aveiro 50, 3050-420 Pampilhosa – Portugal | Tel.: (+351) 239 490100 | Fax: (+351) 231 949292 | [comercial@fucoli-somepal.pt](mailto:comercial@fucoli-somepal.pt)

**ROUND MANHOLE COVER  
SERIES EIXO E DOBRADIÇA  
C250 and D400**

12.100



Model with 75 mm height frame



Model with 100 mm height frame



Series Águas do Porto

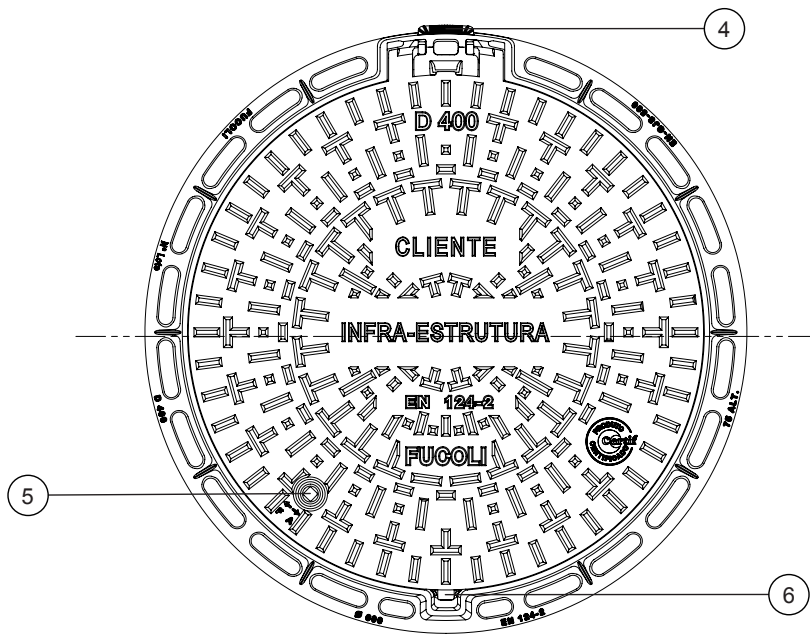
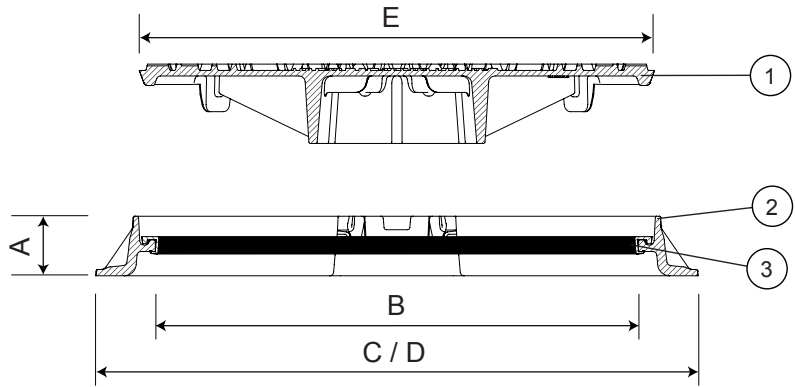

**Product features**

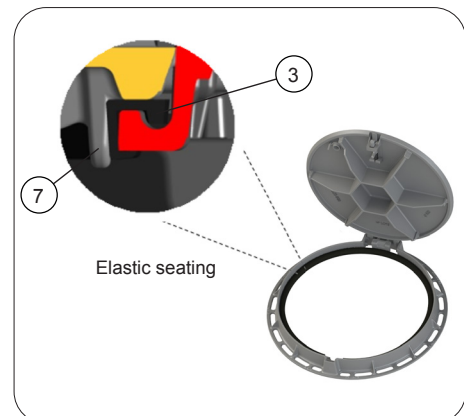
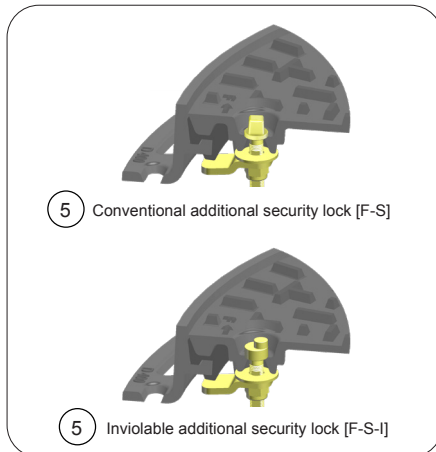
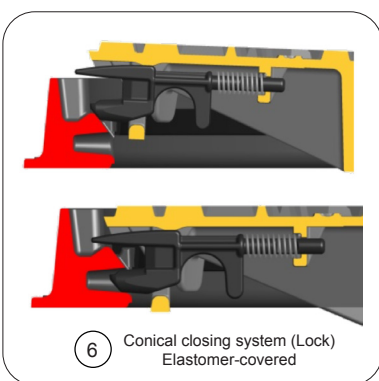
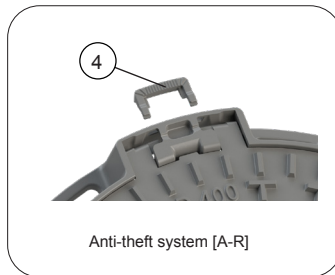
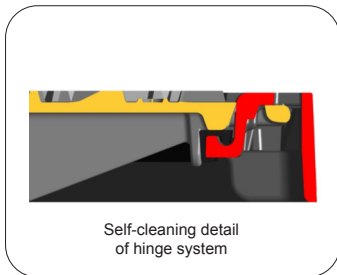
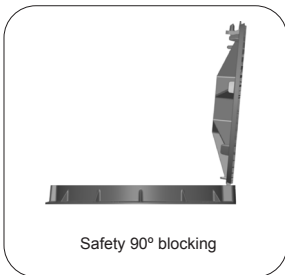

continued on next page

# ROUND MANHOLE COVER SERIES EIXO E DOBRADIÇA C250 and D400

12.100



continued from previous page

## Component list

pos.	components	material	standard
1	Cover	Ductile iron EN-GJS-500-7	EN 1563
2	Frame	Ductile iron EN-GJS-500-7	EN 1563
3	Elastic seating anti-noise	EVA copolymer	-
4	Anti-theft system [A-R]	Ductile iron EN-GJS-500-7	EN 1563
5	Conventional security lock	Steel Zinc plated 8.8	-
6	Lock	Ductile iron EN-GJS-500-7	EN 1563
7	Lock covering	Elastomer	EN 681 -1
8	Guide of the cover	Ductile iron EN-GJS-500-7	EN 1563

## Reference and dimensions

Subtitle:  
Lock - Conical closing system  
[F-S] - Conventional security lock  
[F-S-I] - Inviolable security lock  
[A-R] - Anti-theft system

DN - Class - Model	code	Lock	[F-S]	[F-S-I]	[A-R]	Frame				Cover	Weight	
						height	clear opening	ø external	ø ext. with stone-bolt	ø external	Cover kg	Total kg
						mm	mm	mm	mm	mm	approx.	approx.
600 - D400 75 Height	24B1CI4EAFBZZZZ00EE	•				75	600	765	765	650	31	50
600 - D400 75 Height	24B1CI4EAFBZZZZ00GE	•	•			75	600	765	765	650	31	50
600 - D400 75 Height	24B1CI4EAFBZZZZ00HE	•		•		75	600	765	765	650	31	50
600 - D400 75 Height	24B1CI4EAFBZZZZ00IE	•			•	75	600	765	765	650	31	50
600 - D400 75 Height	24B1CI4EAFBZZZZ00JE	•	•		•	75	600	765	765	650	31	50
600 - D400 75 Height	24B1CI4EAFBZZZZ00KE	•		•	•	75	600	765	765	650	31	50
600 - D400 100 Height	24B1CI4EAIBZZZZ00EE	•				100	600	850	850	650	31	55
600 - D400 100 Height	24B1CI4EAIBZZZZ00GE	•	•			100	600	850	850	650	31	55
600 - D400 100 Height	24B1CI4EAIBZZZZ00HE	•		•		100	600	850	850	650	31	55
600 - D400 100 Height	24B1CI4EAIBZZZZ00IE	•			•	100	600	850	850	650	31	55
600 - D400 100 Height	24B1CI4EAIBZZZZ00JE	•	•		•	100	600	850	850	650	31	55
600 - D400 100 Height	24B1CI4EAIBZZZZ00KE	•		•	•	100	600	850	850	650	31	55
600 - Águas do Porto	24B1CI4EAIEZZAPT20GE	•	•			100	600	850	850	650	31	55
600 - Águas do Porto	24B1CI4EAIEZZAPT20JE	•	•		•	100	600	850	850	650	31	55
600 - D400 Intense Traffic	24B1CI4IAIBZZZZ00EE	•				100	600	850	850	650	40	64
600 - D400 Intense Traffic	24B1CI4IAIBZZZZ00IE	•			•	100	600	850	850	650	40	64
750 - D400 100 Height	24B1CX4EAIBZZZZ00EE	•				100	750	1006	1006	805	53	81
750 - D400 100 Height	24B1CX4EAIBZZZZ00IE	•			•	100	750	1006	1006	805	53	81
600 - C250 75 Height	24B1CI3EAFBZZZZ00EE	•				75	600	765	765	605	31	50
600 - C250 75 Height	24B1CI3EAFBZZZZ00GE	•	•			75	600	765	765	605	31	50
600 - C250 75 Height	24B1CI3EAFBZZZZ00IE	•			•	75	600	765	765	605	31	50
600 - C250 75 Height	24B1CI3EAFBZZZZ00JE	•	•		•	75	600	765	765	605	31	50



**Fucoli Somepal**  
FUNDAÇÃO DE FERRO, S. A.

Visit our website at [www.fucoli-somepal.pt](http://www.fucoli-somepal.pt)

Head office: Estrada de Coselhas, 3000-125 Coimbra – Portugal | Tel.: (+351) 239 490100 | Fax: (+351) 239 490198

Branch office: Rua de Aveiro 50, 3050-420 Pampilhosa – Portugal | Tel.: (+351) 239 490100 | Fax: (+351) 231 949292 | [comercial@fucoli-somepal.pt](mailto:comercial@fucoli-somepal.pt)



100% MADE IN EUROPE