

RECTANGULAR MANHOLE COVER

SERIES UF

B125

12.402



Product description

- Rectangular manhole cover series UF
- Water based black painting

Installation location

- Class B125 - Footways, pedestrian areas and comparable areas, car parks or car parking decks

Standards

- Designed according to EN 124-1/2

Certifications

- Certificate Certif DDA - 002/2021

Features

- Ductile cast iron cover (EN-GJS-500-7) with water based black painting and steel zinc frame
- Cover with non-slip raised pattern according to EN 124-1 designed to allow quick and easy installation
- Cover with fixed supports in NBR sealing for silent operating
- Frame with stone-bolt for fixing
- Characterized for its great dimensions and the modularity, in such a way that the same cover can be used in three distinct frames
- This model is used in situations where is necessary an large access zones to do interventions
- Available in 3 models:
 - A. 633 x 495 model consisting of 1 cover + frame
 - B. 1266 x 495 model consisting of 2 covers + frame
 - C. 1899 x 495 model consisting of 3 covers + frame
- Personalization of the cover with inscriptions and logo in high relief with minimal quantities
- On request hot dip galvanized frame.

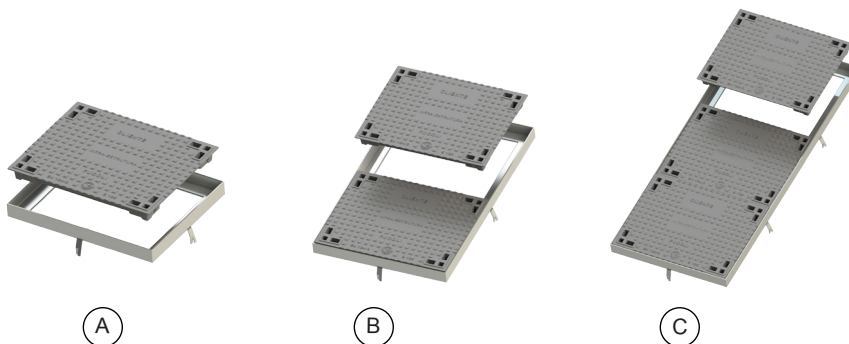

Fucoli Somepal
FUNDAÇÃO DE FERRO, S.A.

Visit our website at www.fucoli-somepal.pt

Head office: Estrada de Coselhas, 3000-125 Coimbra – Portugal | Tel.: (+351) 239 490100 | Fax: (+351) 239 490198

Branch office: Rua de Aveiro 50, 3050-420 Pampilhosa – Portugal | Tel.: (+351) 239 490100 | Fax: (+351) 231 949292 | comercial@fucoli-somepal.pt

RECTANGULAR MANHOLE COVER SERIES UF B125

12.402



Tree models available

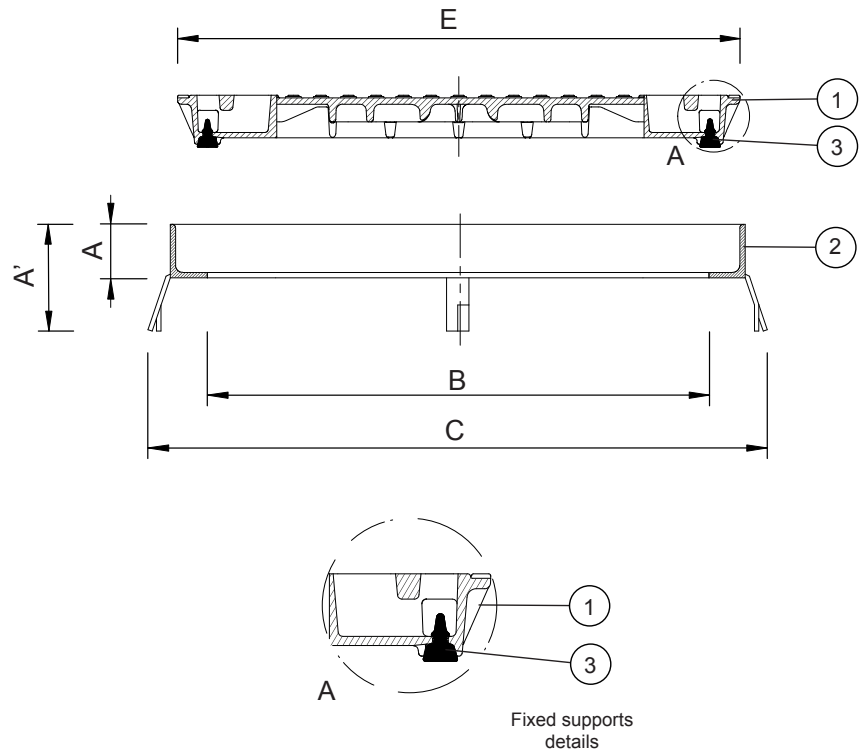
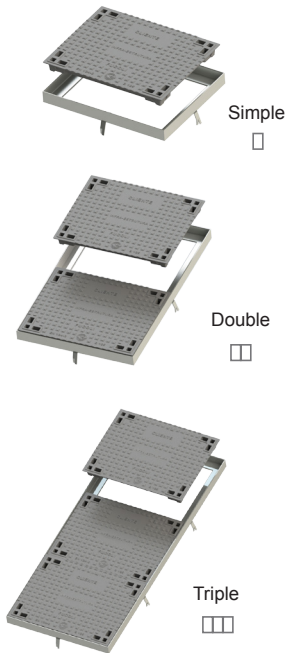

Component list

pos.	components	material	standard
1	Cover	Ductile iron EN-GJS-500-7	EN 1563
2	Frame	Steel zinc	-
3	Fixed supports	Elastomer NBR	EN 549

Reference and dimensions

Modelo - Class	code	Frame				Cover	Weight	
		height mm	height with stone-bolt mm	clear opening mm	ext. with stone-bolt mm	external mm	Cover kg	Total kg
		A	A'	B	C	E	approx.	approx.
☐ UF Simple - B125	24D1CM2VNEBZZZZ00AG	60	110	527 x 389	647 x 509	633 x 495	30	41
☐☐ UF Double - B125	24D1DV2VNEFZZZZ00AG	60	110	884 x 527	1004 x 647	(2) 633 x 495	(2) 30	76
☐☐☐ UF Triple - B125	24D1FT2VNEFZZZZ00AG	60	110	1380 x 527	1500 x 647	(3) 633 x 495	(3) 30	111
☐ Frame UF Simple - B125	20429012	60	110	527 x 389	647 x 509	-	-	11
☐☐ Frame UF Double - B125	20429022	60	110	884 x 527	1004 x 647	-	-	17
☐☐☐ Frame UF Triple - B125	20429032	60	110	1380 x 527	1500 x 647	-	-	23
☐ Cover UF - B125	24Q1CM2VNABZZZZ00AG	60	110	-	-	633 x 495	30	30



Fucoli Somepal
FUNDIÇÃO DE FERRO, S.A.

Visit our website at www.fucoli-somepal.pt

Head office: Estrada de Coselhas, 3000-125 Coimbra – Portugal | Tel.: (+351) 239 490100 | Fax: (+351) 239 490198

Branch office: Rua de Aveiro 50, 3050-420 Pampilhosa – Portugal | Tel.: (+351) 239 490100 | Fax: (+351) 231 949292 | comercial@fucoli-somepal.pt



100% MADE IN EUROPE