



Product description

- Fire hydrant series CLASSIC prepared for water supply in fire-fighting, supply of potable water and filtered neutral liquids
- Service temperature from 0°C (excluding frost) to 70°C
- Maximum allowable operating pressure (PFA); Allowable maximum operating pressure PN20 (PMA); Allowable test pressure PN25 (PEA)

Standards

- Designed according to EN14384 and EN 1074-6
- Flange drilling to EN 1092-2

Tests

All fire hydrant are individually hydrostatically tested according to EN 1074-6 and EN 14384

Corrosion protection

- Epoxy coating inside and outside, approved for potable water, with a minimum thickness of 250 µm, approved epoxy coating fusion bonded according EN 14901-1 and GSK approved; the exterior above the ground line is coated with a second finish in enamel and polyurethane, in a red color resistant to UV rays

Approvals

- Certified according to EN 14384: Certif certificate ESI-003/2023
- CE mark according to EN 14384: Performance Statement certificate 1328-CPR-0065
- ACS Potability Certificate 23 ACC NY 534
- GSK Epoxy Coating Certificate GSK-ID:1247 (RAL-GZ 662)

Others

- Fucoli-Somepal is registered with the ANPC under No. 197 (under Ordinance 773/2009)
- Fucoli-Somepal is vogal at CT 46/SC2/SG1-1 (hydrant)

Features

- For water supply in fire fighting and supply of drinking water and neutral liquids
- Simple installation and quick operation
- When installed and after loosening the fusible flange bolts, they allow the upper body to rotate 360°
- Equipped with storz plugs that include a de-pressurization mechanism that makes it possible to release the internal pressure
- Easy maintenance, with removable sealing system, without having to remove the hydrant from the pipeline
- In the event of an occasional impact that causes a break, sectioning of the frame occurs through the fracture of the fuse flange, allowing its repair under load using only the replacement kit
- Fire frame comes equipped with an integrated drainage system (dry column - Type C). When the column is closed, it automatically empties. Landmark drain time 6,4 minutes
- Fire frame supplied as standard with DN100 double flanged 90° duck-foot bend, on request it can be supplied with movable flanged uPVC socket 90° duck-foot bend, on request it can be supplied with flanged reduction bend of DN100/80, or flange/mouth bend for PVC pipe DN100/110 or DN100/90 with duck-foot
- Accessories: key for fire hydrants [ref.07.500], key for inviolable blank caps [ref. 07.500] and replacement kit [ref. 07.501]
- On request, the fire hydrant can be supplied in other colours; with red bonnet; stem in stainless steel AISI 316L or other; inviolable bank cap or seals in NBR.



Fucoli-Somepal
FUNDAÇÃO DE FERRO, S. A.

Visit our website at www.fucoli-somepal.pt

Head office: Estrada de Coselhas, 3000-125 Coimbra – Portugal | Tel.: (+351) 239 490100

Branch office: Rua de Aveiro 50, 3050-420 Pampilhosa – Portugal | Tel.: (+351) 239 490100 | comercial@fucoli-somepal.pt



Classic

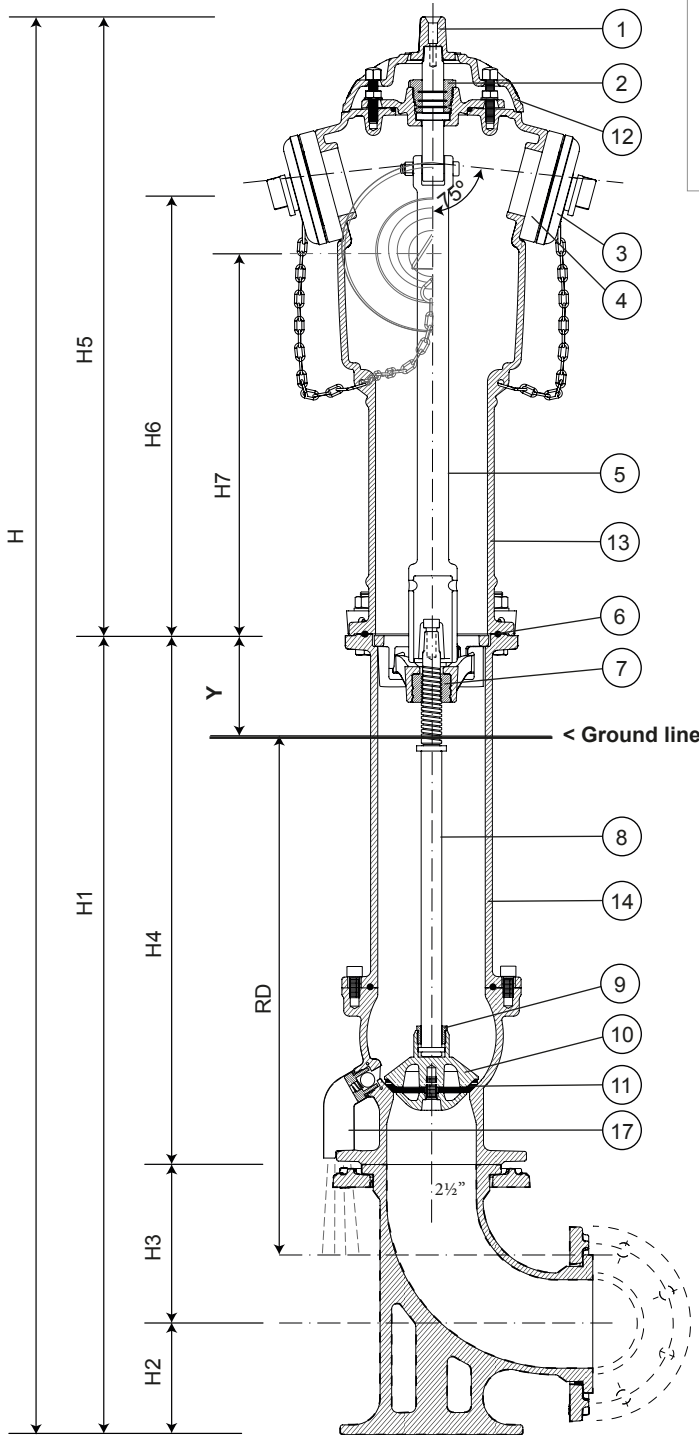

Fire hydrant Classic illustrated option A - Double flanged 90° duckfoot bend DN100

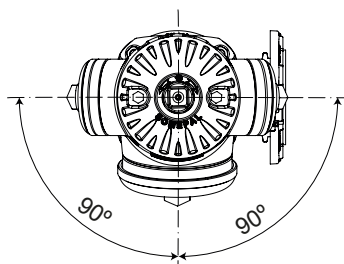

Terms of use

- Allowable operating pressure (PFA) 16 bar
- Number of turns to open fully: 10 turns left
- Drain valve maximum flow time 6,4 min/m
- Volume of retained water 10 ml
- Maximum operating torque (MOT): 125Nm
- Minimum strength torque (mST): 250Nm

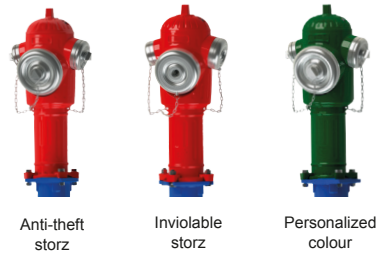

Anti-theft storz

Inviolable storz

Personalized colour

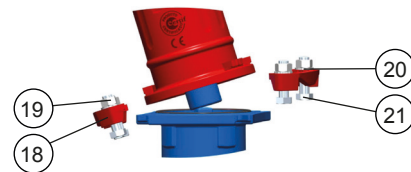

In case of occasional impact, use only the replacement kit

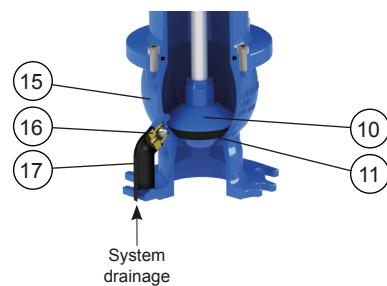

HYDRAULIC CHARACTERISTICS
Minimum flow coefficient for different connection types and MI height

storz	(Kv)
52 (DN 50)	69
75 (DN 65)	112
110 (DN 100)	164



continued from previous page

Component list

pos	components	material	standards
1	Stem cap	Ductile iron EN-GJS-500-7	EN 1563
2	Upper body gland	Brass	EN 12164
3	Storz cap	Aluminium	-
4	Storz coupling	Aluminium	-
5	Upper stem rod	Ductile iron EN-GJS-500-7	EN 1563
6	Support	Ductile iron EN-GJS-500-7	EN 1563
7	Wedge nut	Brass	EN 12164
8	Stem	Stainless steel AISI 420	EN 10088-1
9	Obturator fixed nut	Brass	EN 12164
10	Obturator	Ductile iron EN-GJS-500-7	EN 1563
11	Obturator joint	Elastomer EPDM WA	EN 681-1
12	Cover	Ductile iron EN-GJS-500-7	EN 1563
13	Body superior	Ductile iron EN-GJS-500-7	EN 1563
14	Intermediate body inferior	Ductile iron EN-GJS-500-7	EN 1563
15	Body inferior	Ductile iron EN-GJS-500-7	EN 1563
16	Automatic ball drain	Brass	-
17	Drain pipe	PE	-
18	Flange fuse	Ductile iron EN-GJS-500-7	EN 1563
19	Nuts	Stainless steel A4	EN 10088-1
20	Washers	Stainless steel A2	EN 10088-1
21	Bolts	Stainless steel A2	EN 10088-1

Reference and dimensions

DN	code	RD mm	Y mm	H mm	H1 mm	H2 mm	H3 mm	H4 mm	H5 mm	H6 mm	H7 mm	water outlets			turns to open	Kg approx.
												type	front	side		
100	11210020	670	60	1605	905	125	180	600	700	505	435	Anti-theft storz	110	75 52	10	53
100	11210060	670	60	1605	905	125	180	600	700	505	435	Anti-theft storz	110	75 75	10	53
100	11210040	670	60	1605	905	125	180	600	700	505	435	Anti-theft storz	75	52 52	10	53
100	1121002002	1000	60	1880	1180	125	180	875	700	505	435	Anti-theft storz	110	75 52	10	57
100	1121006002	1000	60	1880	1180	125	180	875	700	505	435	Anti-theft storz	110	75 75	10	57
100	1121004002	1000	60	1880	1180	125	180	875	700	505	435	Anti-theft storz	75	52 52	10	57
100	-	1250	60	2195	1495	125	180	1190	700	505	435	Anti-theft storz	110	75 52	10	53
100	-	1250	60	2195	1495	125	180	1190	700	505	435	Anti-theft storz	110	75 75	10	53
100	-	1250	60	2195	1495	125	180	1190	700	505	435	Anti-theft storz	75	52 52	10	53
100	11210070	670	60	1605	905	125	180	600	700	505	435	Inviolable storz	110	75 52	10	57
100	-	670	60	1605	905	125	180	600	700	505	435	Inviolable storz	110	75 75	10	57
100	11210080	670	60	1605	905	125	180	600	700	505	435	Inviolable storz	75	52 52	10	57
100	112100702	1250	60	2195	1495	125	180	1190	700	505	435	Inviolable storz	110	75 52	10	57
100	-	1250	60	2195	1495	125	180	1190	700	505	435	Inviolable storz	110	75 75	10	57
100	-	1250	60	2195	1495	125	180	1190	700	505	435	Inviolable storz	75	52 52	10	57
100	11209510	670	60	1605	905	125	180	600	700	505	435	Guillemin	100	65 65	10	53
100	1120951002	1000	60	1880	1180	125	180	875	700	505	435	Guillemin	100	65 65	10	57
100	11209505	670	60	1605	905	125	180	600	700	505	435	Guillemin	80	40 40	10	53
100	-	1250	60	2195	1495	125	180	1190	700	505	435	Guillemin	100	65 65	10	53
100	-	1250	60	2195	1495	125	180	1190	700	505	435	Guillemin	80	40 40	10	53
100	11210036	670	60	1605	905	125	180	600	700	505	435	BSRT BS336	4"	2 ^{1/2} " 2 ^{1/2} "	10	53
100	-	670	60	1605	905	125	180	600	700	505	435	BS336	-	2 ^{1/2} " 2 ^{1/2} "	10	53
100	-	670	60	1605	905	125	180	600	700	505	435	BS336	-	2" 2"	10	53
100	-	1250	60	2195	1495	125	180	1190	700	505	435	BSRT BS336	4"	2 ^{1/2} " 2 ^{1/2} "	10	53
100	-	1250	60	2195	1495	125	180	1190	700	505	435	BS336	-	2 ^{1/2} " 2 ^{1/2} "	10	53
100	-	1250	60	2195	1495	125	180	1190	700	505	435	BS336	-	2" 2"	10	53

continued on next page



continued from previous page

Option A - Double flanged 90° duck-foot bend



Double flanged 90° duck-foot bend [ref.10.1004]

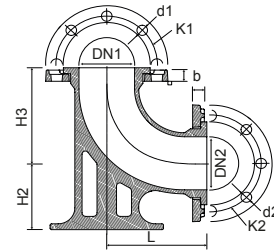

DN1 DN2	PN	code	L mm	H2 mm	H3 mm	K1 mm	n° x d1 mm	K2 mm	n° x d2 mm	b mm	Kg approx.
100	10/16	10001065	180	125	180	180	8 x 19	180	8 x 19	21	16
100 80	10/16	100010651	180	125	180	180	8 x 19	160	8 x 19	21	15

Option B - Movable flanged uPVC socket 90° duck-foot bend



On request movable flanged uPVC socket 90° duck-foot bend [ref.10.104]

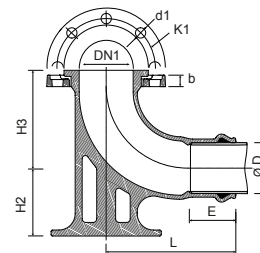

DN1	Ø D ext. PVC	PN	code	L mm	E min	H2 mm	H3 mm	K1 mm	n° x d1 mm	b mm	Kg approx.
100	90	10/16	10001064	240	86	125	305	180	8 x 19	19	14
100	110	10/16	10001066	260	115	125	305	180	8 x 19	19	15